



COLOUR TELEVISION

AV-29JS25
AV-29MS25
AV-29MX55
AV-29MX75
AV-29VX15
AV-29VX25
AV-29WX25

AV-25MS25
AV-25MX55
AV-25MX75
AV-25VX15

AV-21MS25
AV-21MX55
AV-21MX75
AV-21VX15
AV-21WX25

EQUALIZER • CINEMA SURROUND • COMPONENT INPUT

Contents

Knowing your TV's features	3
Remote control buttons and basic functions	4
TV buttons and functions	6
Setting up your TV	7
Basic setting for picture	9
Advanced setting for picture	11
Original features for picture	12
Basic setting for sound	14
Advanced setting for sound	15
DVD Function	16
Customized setting	17
TV channel presetting	19
Additional preparation	22
Troubleshooting	23
Specifications	Back cover

INSTRUCTIONS

Thank you for buying this JVC colour television.

To make sure you understand how to use your new TV, please read this manual thoroughly before you begin.

WARNING: TO PREVENT FIRE OR SHOCK HAZARD, DO NOT EXPOSE THIS APPLIANCE TO RAIN OR MOISTURE.

CAUTION: TO ENSURE PERSONAL SAFETY, OBSERVE THE FOLLOWING RULES REGARDING THE USE OF THIS TV.

- 1 Operate only from the power source indicated on the rear of the TV.
- 2 Avoid damaging the power cord and mains plug. When unplugging the TV, grasp the mains plug. Do not pull on the power cord.
- 3 Never block or cover the ventilation openings.
Never install the TV where good ventilation is unattainable.
When installing this TV, leave spaces for ventilation around the TV of more than the minimum distances as shown.

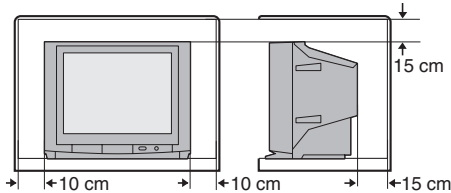

- 4 Do not allow objects or liquid into the cabinet openings.
- 5 In the event of a fault, unplug the unit and call a service technician. Do not attempt to repair it yourself or remove the rear cover.
- 6 The surface of the TV screen is easily damaged. Be very careful with it when handling the TV. Should the TV screen become soiled, wipe it with a soft dry cloth. Never rub it forcefully. Never use any cleaner or detergent on it.

- 7 If you are not going to use this TV for a long period of time, be sure to disconnect the AC plug from the AC socket.
- 8 The apparatus shall not be exposed to dripping or splashing and that no objects filled with liquids, such as vases, shall be placed on the apparatus.

WARNING: <AV-21WX25 only>

A REMOVABLE PLASTIC COVER IS FIXED TO THE TELEVISION'S FRONT AUDIO/VIDEO CONNECTOR. TO PREVENT THIS COVER FROM BEING ACCIDENTALLY SWALLOWED BY BABIES OR CHILDREN, REMOVE IT FROM THE TELEVISION AND STORE IT IN A SAFE PLACE. IF THE COVER IS SWALLOWED SEEK THE ADVICE OF A DOCTOR IMMEDIATELY.

<AV-21M, AV-25M, AV-29M Series>

YOU CAN DETACH THE PROTECT SHEET ON THE TOP AND BOTTOM OF FRONT FRAME IF YOU NEEDED. THE FRONT BUTTON DOOR OF THE TV SHOULD BE PULLED OUT FROM ITS BOTTOM. DO NOT PRESS THE UPPER PART, OR YOUR FINGER MAY BE PINCHED.

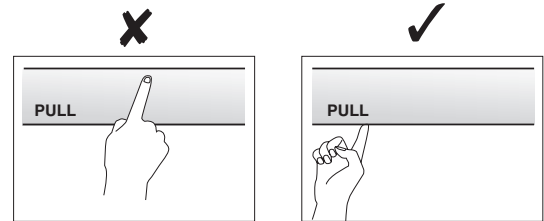

Knowing your TV's features

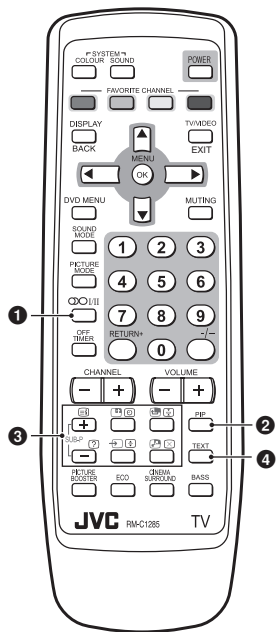

Main features

DVD FUNCTION	Just connect DVD player to the television. The television will detect DVD signal and display picture on the screen automatically and you can adjust pictures and sound while you are watching DVD as your desire.
PIP (Picture in Picture)	You can view two different sources (e.g. TV programme and VCR sources) at the same time.
TELETEXT	You can view teletext programmes which are broadcasted by some TV channels. Teletext programme is an information in text form.
A2/NICAM (STEREO / I-II)	You can listen to the stereo sound or bilingual sound from TV programme broadcasting by A2 or NICAM Sound-multiplex system.
FAVORITE CH (Channel)	You can register up to four favorite channels for quick recall with one press.
AI ECO	TV detects the brightness of your room and automatically adjust the picture brightness to a suitable level for a better eye care.
AI VOLUME	TV adjusts the volume automatically to the same level for all TV channels to avoid sudden change of the volume when selecting different TV channel or selecting Video Mode.

Confirm your TV's functions

Some functions written in this instruction manual may not be available for your TV.

Please see the chart below and check the functions that are equipped for your TV's model number. The model number is indicated at the rear of your TV. When you press a button concerned to a function that is not available for your TV, it does not work and the logo "Ø" appears on the screen.

NO.	Function	Model No.															
		AV-29VX15	AV-29VX25	AV-29VX25	AV-29JLS25	AV-29IMS25	AV-29IMX55	AV-29IMX75	AV-25VX15	AV-25IMS25	AV-25IMX55	AV-25IMX75	AV-21VX15	AV-21WX25	AV-21IMS25	AV-21IMX55	AV-21IMX75
①	⊙⊙I/II (STEREO/I-II)	-	-	○	-	-	-	○	-	-	-	-	-	○	-	-	
② ③	PIP control buttons (Green label)	-	-	-	○	○	-	-	○	○	-	-	-	-	-	○	○
④ ③	TELETEXT control buttons (Black label)	-	○	○	-	○	-	○	-	○	-	○	○	-	-	-	○
-	PICTURE TILT	○	○	○	○	○	-	-	-	-	-	-	-	-	-	-	-

Remote control buttons and basic functions

No.	Press	To
1	POWER	Turn on or off the TV from standby mode.
2	MENU/OK	Display menu and confirm selected function.
3	▲ / ▼ / ◀ / ▶	Select and adjust menu function.
4	CHANNEL +/-	Select the desired channel number.
5	VOLUME +/-	Adjust the volume level.
6	TV/VIDEO	Select TV or video terminal input.
7	MUTING	Turn off the volume. Press this button again to resume the volume.
8	DISPLAY /BACK	Display the programme number or video terminal number, stereo/bilingual broadcast system and PR list (channel list) on the screen. You can select the channel using the PR list. 1 Press the DISPLAY button once to display the PR list. 2 Press ▲ / ▼ / ◀ / ▶ buttons to choose a channel, then press the MENU/OK button. You can confirm the favorite channels in the PR list. The channels set to favorite channels are indicated with coloured mark. On the other hand, you can use this button to return to the previous menu.
9	0-9, -/--	Select the programme number. For two digits programme number, press -/--, then press the number button.
10	RETURN+	a) Return to the frequently view channel with one touch. 1 Choose the channel you want to register. 2 Press and hold RETURN+ button until "RETURN PLUS PROGRAMMED!" appears. To cancel, press and hold RETURN+ button until "RETURN PLUS CANCELED!" appears. b) Return to the previously viewed channel, if you have not set or have cancelled the Return channel as above.

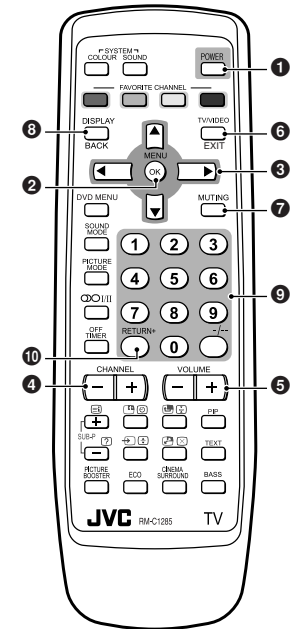

Remote control buttons and basic functions (continued)

How to operate menus and menus locations

To	Operation	Note
Display the MENU	Press the MENU/OK button ②.	To exit the MENU, press the DISPLAY/BACK button ⑧ or choose EXIT menu or TV/VIDEO/EXIT button ⑥.
Display the top menu	Press ▲/▼ buttons ③ to choose a menu title. Then press MENU/OK button ②.	Press ▼ button ③ to display the next page for more functions.
Display the 2nd menu	Press ▲/▼ buttons ③ to choose a menu title. Then press MENU/OK button ②.	
Display the 3rd menu	Press ▲/▼ buttons ③ to choose a menu title. Then press MENU/OK button ②.	
Return to the previous menu	Press the DISPLAY/BACK button ⑧.	–
Choose the setting of a function	Press ▲/▼ buttons ③ to choose a function. Then press the ◀/▶ buttons ③ to change the setting.	Press the TV/VIDEO/EXIT button ⑥ to exit from the menu.
Adjust the effect level of a function	Press ▲/▼ buttons ③ to choose a function. Then press the ◀/▶ buttons ③ to adjust the effect level.	
Display the sub menu of a function.	Press the ▲/▼ buttons ③ to choose a function. Then press MENU/OK button ② to display the sub menu.	–

The following chart shows locations of functions in menus. In this manual, location of a function is described as follows:

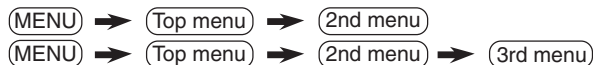

Note: Some functions have the 4th menus as the sub-menus.

MENU	Top menu	2nd menu	Location	3rd menu	Location	
MENU	PICTURE	PICTURE MODE	P.9	–	–	
		PICTURE SETTING	CONTRAST	P.10		P.10
			BRIGHT			P.10
			SHARP			P.10
			COLOUR			P.10
	TINT			P.10		
	WHITE BALANCE	P.10	–	–		
	VNR	P.17				
	SOUND	STEREO/HI	P.15	–	–	
		AI VOLUME	P.15	–	–	
		SOUND MODE	P.14	–	–	
		EQUALIZER	P.15	–	–	
		BALANCE	P.14	–	–	
	CINEMA SURROUND	P.15	–	–		
	FEATURES	DVD MENU	P.16	AUTO SIGNAL DETECT	P.16	
				DVD PICTURE MODE	P.16	
				TINT COLOUR	P.16	
				WHITE BALANCE	P.16	
				SOUND MODE	P.16	
		CINEMA SURROUND	P.16			
OFF TIMER		P.17	–	–		
CHILD LOCK		P.17	–	–		
COMPRESS (16:9)	P.11	–	–			
AI ECO SENSOR	P.11	–	–			
INSTALL	SETUP TOUR	P.18	–	–		
	AUTO PROGRAM	P.19	–	–		
	EDIT/MANUAL	P.19	DELETE, MOVE, MANUAL, INSERT	P.19-P.20		
	COLOUR SYSTEM	P.9	–	–		
	LANGUAGE	P.17	LANGUAGE	P.17		
	TEXT LANGUAGE	P.13	TEXT LANGUAGE	P.13		
	VIDEO-2 SETTING	P.18	–	–		
BLUE BACK	P.11	–	–			
PICTURE TILT	P.11	–	–			
EXIT	–	–	–	–		

TV buttons and functions

The illustrations shown below is for AV-29VX15, AV-25MX75 and AV-21MX75 only, which are used for explanation purpose. Your TV may not look exactly the same as illustrated.

Front of the TV

AV-29VX15

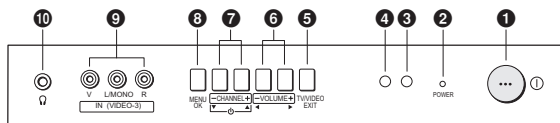

AV-21MX75/AV-25MX75

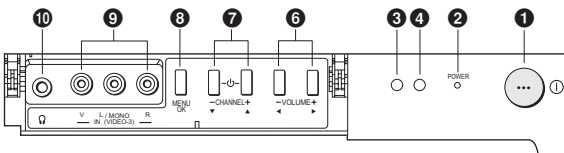

Rear of the TV

AV-29VX15

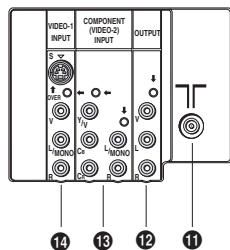

No.	Button/terminal	Description	Page
①	① (main power)	Press to turn on or turn off the TV's main power.	–
②	POWER lamp	Indicate the TV is being turned on or off. No colour : TV's main power is being turned off. Red : TV's main power is being turned on. Note: When you turn off the power switch while TV is in standby mode, the light of power lamp will be off in 10 -15 seconds.	–
③	ECO sensor		–
④	Remote control sensor		–
⑤	TV/VIDEO/EXIT	Press to select TV or Video terminal input or exit from menu.	–
⑥	VOLUME -/+	Press to adjust the volume level.	–
⑦	CHANNEL -/+	Press to select the desired channel.	–
⑧	MENU	Press to display the menu.	–
⑨	IN (VIDEO-3)	Video and audio input jacks for VIDEO-3 mode.	22
⑩	Headphone jack.		22
⑪	Aerial socket.		7
⑫	OUTPUT	Video and audio output jacks. (The component video signal cannot be output.)	22
⑬	COMPONENT (VIDEO-2) INPUT	Video or component video, and audio input jacks for VIDEO-2 mode. You can select the input signal by setting the "VIDEO-2 SETTING" function (see page 18).	22
⑭	VIDEO-1 INPUT	Video or S-VIDEO, and audio input jacks for VIDEO-1 mode	7

How to operate the menus with the TV button

TV button	Work as same as the button on the remote control unit	Note
MENU	MENU/OK button	To display main menu and exit menu after finish setting.
CHANNEL -/+	▼/▲ button	To select menu function.
VOLUME -/+	◀/▶ button	To adjust the desired function.

Setting up your TV

CAUTION

- Turn off the equipment including the TV before connecting.

1 Connecting the aerial cable.

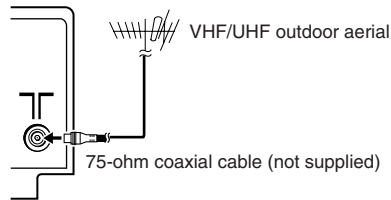

If you connect a VCR, connect the aerial output jack of your VCR and the aerial jack on the TV with aerial cable. Then connect the output jacks of your VCR and the VIDEO-1 input jacks of the TV with the video cable (or S-VIDEO cable if available) and audio cables. For details, see the manual of your VCR.

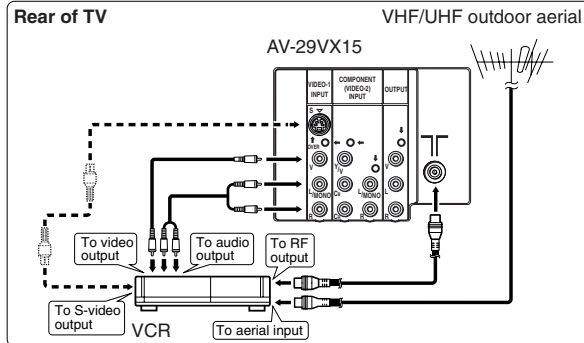

The illustration shown is just a sample. It may not be same as your TV.

2 Connecting the compatible main plug to the AC outlet.



3 Inserting batteries into the remote control.

Insert two batteries by following the ⊕ and ⊖ polarities and inserting the ⊖ end first.

CAUTION:

Follow the cautions printed on the batteries.

Notes:

- Use AA/R6/UM-3 dry cell batteries.
- If the remote control does not work properly, fit new batteries. The supplied batteries are for testing, not regular use.

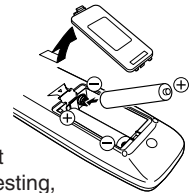

4 Turn on the TV by pressing the main power button.

JVC logo appears on the screen.



JVC logo will appear on the screen again at the phase of "SETUP TOUR RESTART?" function. Then the initial setting can be performed according to page 8.

Setting up your TV (continued)

5 Making the initial settings

Set up your TV by pressing MENU/OK button or waiting for 15 seconds, then operate the TV by following the steps as below:



- Press ▲/▼ button to select your desired language*.

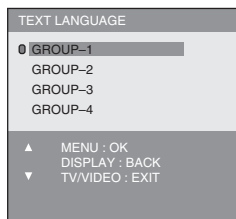

- Press ▲/▼ button to select your desired Teletext language group*. For details, see page 13. (For JS25/MS25/MX75/VX25/WX25 series only)

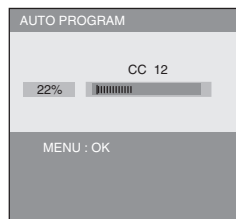

- TV will start searching for the channels.

To stop AUTO PROGRAM, press MENU/OK button.

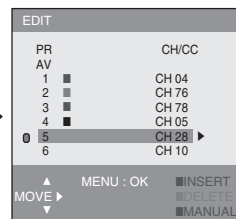

- To complete the initial setting, press the MENU/OK button. To edit the channel list, see page 19.

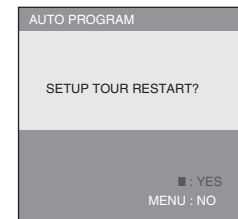

- After that, when turn on the TV at the next time. "SETUP TOUR RESTART?" will be displayed. Press the MENU/OK button to cancel the SETUP TOUR RESTART function. If you want to make initial settings again when the next time you turn on the TV, press the Red button to activate the SETUP TOUR RESTART function.

* If the TEXT function is available for your TV and the LANGUAGE shown follow as ENGLISH/РУССКИЙ/عربي /فارسی /FRANÇAIS, you can select the TEXT LANGUAGE group from GROUP-1 to GROUP-4.

If the TEXT function is available for your TV and the LANGUAGE shown follow as ENGLISH/РУССКИЙ/中文/MELAYU/INDONESIA, you can select the TEXT LANGUAGE group from GROUP-1 to GROUP-3.

Basic setting for picture

COLOUR SYSTEM

You can select the appropriate colour system when the picture is not clear or no colour appears.

Press the COLOUR SYSTEM button to select a setting.

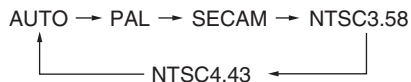

To operate this function with a menu:

* (MENU) ➔ (INSTALL menu) ➔ (COLOUR SYSTEM)

For the colour system in each country or region, see the table below:

Area	Country or Region	System
Asia, Middle East	Bahrain, Kuwait, Oman, Qatar, United Arab Emirates, Yemen, etc.	PAL
	Indonesia, Malaysia, Singapore, Thailand, India, etc.	PAL
	China, Vietnam, etc.	PAL
	Hong Kong, etc.	PAL
	Islamic Republic of Iran, Lebanon, Saudi Arabia, etc.	SECAM
Europe	Philippines, Taiwan, Myanmar, etc.	NTSC
	Russia, etc.	SECAM
	Czech Republic, Poland, etc.	PAL
	Germany, Holland, Belgium, etc.	PAL
	UK, etc.	PAL
Oceania	Australia, New Zealand, etc.	PAL
Africa	Republic of South Africa, etc.	PAL
	Nigeria, etc.	PAL
	Egypt, Morocco, etc.	SECAM

PICTURE MODE

You can choose the desired picture setting with one-touch.

Press the PICTURE MODE button to select a setting.

SOFT	Softens contrast and sharpness.
BRIGHT	Heightens contrast and sharpness.
STANDARD	Standard picture setting.
USER	You can change this picture setting as you like. Select USER and adjust following items in the PICTURE SETTING menu. (CONTRAST, BRIGHT, SHARP, COLOUR, TINT*)

When you select to VIDEO-2 Mode. You can not adjust SHARP and TINT.

*TINT can only be adjusted in NTSC system.

To operate this function with a menu:

* (MENU) ➔ (PICTURE menu) ➔ (PICTURE MODE)

To return the USER setting to the default, press the blue button when the PICTURE SETTING menu appears.

* About the basic operations of the menu, please see the “How to operate menus and menus locations” on page 5.

Basic setting for picture (continued)

PICTURE SETTING

You can adjust the desired picture setting when selecting USER in PICTURE MODE.

1 Select the USER in PICTURE MODE under PICTURE menu.

* (MENU) → (PICTURE menu) → (PICTURE MODE)
→ (USER)

2 Select the PICTURE SETTING in PICTURE menu, then adjust the setting.

* (MENU) → (PICTURE menu) → (PICTURE SETTING)

CONTRAST	◀ : Lower contrast	▶ : Higher contrast
BRIGHT	◀ : Darker	▶ : Brighter
SHARP	◀ : Softer	▶ : Higher
COLOUR	◀ : Lighter	▶ : Deeper
TINT*	◀ : Reddish	▶ : Greenish

When you select to VIDEO-2 Mode. You can not adjust SHARP and TINT.

* TINT can only be adjusted in NTSC system.

WHITE BALANCE

You can change the white balance of the picture to better match the type of video being viewed.

Select the WHITE BALANCE in the PICTURE menu, then choose the desired setting.

* (MENU) → (PICTURE menu) → (WHITE BALANCE)

NORMAL	Normal white balance.
COOL	Bluish white.
WARM	Reddish white.

When you select to VIDEO-2. You can not adjust WHITE BALANCE. You can adjust it in DVD Menu.

* About the basic operations of the menu, please see the “How to operate menus and menus locations” on page 5.

Advanced setting for picture

AI ECO SENSOR (ECO)

You can adjust TV screen contrast according to the brightness of your room.

Press the ECO button to select the desired mode.

OFF	Cancel the function.
MODE-1	Mild contrast (recommended.)
MODE-2	Even contrast.
DISPLAY	Display the graphic of the function.

To operate this function with a menu:

* (MENU) → (FEATURES menu) → (AI ECO SENSOR)

Correcting the Slanting Picture (PICTURE TILT)

You can correct the picture tilt caused by the earth's magnetic force.

1 Select the PICTURE TILT in the INSTALL menu, then press MENU/OK button.

* (MENU) → (INSTALL menu) → (PICTURE TILT)

The following display appears.



2 Press the ▲/▼ buttons until the picture become level. Then press the MENU/OK button.

COMPRESS (16:9)

You can convert a normal picture (4:3 aspect ratio) into a wide picture (16:9 aspect ratio).

Select the COMPRESS (16:9) in the FEATURES menu, then choose ON or OFF.

* (MENU) → (FEATURES menu) → (COMPRESS (16:9))

BLUE BACK

You can set the TV to automatically change to a blue screen and mute the sound if the signal is weak or absent, or when there is no input from an antenna.

Select the BLUE BACK in the INSTALL menu, then choose ON or OFF.

* (MENU) → (INSTALL menu) → (BLUE BACK)

If you wish to continue viewing the poor picture, cancel the BLUE BACK function.

* About the basic operations of the menu, please see the "How to operate menus and menus locations" on page 5.

Original features for picture (continued)

TEXT LANGUAGE

You can set the Teletext language group that corresponds to the programmes.

Select TEXT LANGUAGE in the INSTALL menu, then choose the desired language group.

* (MENU) → (INSTALL menu) → (TEXT LANGUAGE)

GROUP-1	English, German, Swedish / Finnish / Danish / Hungarian, Italian, French, Spanish / Portuguese, Turkish
GROUP-2	Polish, German, Estonian, Slovenian, Czech / Slovakian, Rumanian
GROUP-3	Polish, German, Estonian, Lettish, Russian, Ukrainian
GROUP-4	English, French, Turkish, Arabic, Iranian

Depending on the broadcast, the language set may not display properly. For details, see in page 8.

* About the basic operations of the menu, please see the “How to operate menus and menus locations” on page 5.

Basic setting for sound

SOUND SYSTEM

You can select an appropriate sound system when abnormal sound occurs even when the picture appears normally. Press the SOUND SYSTEM button to select a setting.

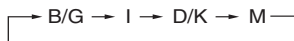

This function is not available in video mode. For the sound system in each country or region, see the table below:

Area	Country or Region	System
Asia, Middle East	Bahrain, Kuwait, Oman, Qatar, United Arab Emirates, Yemen, etc.	B/G
	Indonesia, Malaysia, Singapore, Thailand, India, etc.	I
	China, Vietnam, etc.	D/K
	Hong Kong, etc.	I
	Islamic Republic of Iran, Lebanon, Saudi Arabia, etc.	B/G
Europe	Philippines, Taiwan, Myanmar, etc.	M
	Russia, etc.	D/K
	Czech Republic, Poland, etc.	D/K
	Germany, Holland, Belgium, etc.	B/G
	UK, etc.	I
Oceania	Australia, New Zealand, etc.	B/G
Africa	Republic of South Africa, etc.	I
	Nigeria, etc.	B/G
	Egypt, Morocco, etc.	B/G

SOUND MODE

You can choose the desired sound setting. Select the SOUND MODE in SOUND menu, then choose the setting.

* (MENU) ➔ (SOUND menu) ➔ (SOUND MODE)

USER You can change this sound setting as you like. Select USER and adjust the frequencies in EQUALIZER (100, 300, 1K, 3K, 8K Hz). For details, see "EQUALIZER" on page 15.

SOUND TURBO Emphasize on low and high frequency levels.

THEATER Emphasize on movie sound.

MUSIC Emphasize on music effect.

NEWS Emphasize on vocal sound.

When you select to VIDEO-2. You can not adjust SOUND MODE function. You can adjust it in DVD Menu.

BALANCE

You can adjust the volume balance between the left and right speakers.

Select the BALANCE in SOUND menu, then adjust the setting.

* (MENU) ➔ (SOUND menu) ➔ (BALANCE)

* About the basic operations of the menu, please see the "How to operate menus and menu locations" on page 5.

Advanced setting for sound

CINEMA SURROUND

You can enjoy an enhanced sound for wider audience.
Press the CINEMA SURROUND button to select a setting.

OFF	Cancel the function.
ON	Listen to sound with wider audience effect.

This function is not available when the SOUND MODE is set to SOUND TURBO.



To operate this function with a menu:

* (MENU) → (SOUND menu) → (CINEMA SURROUND)

When you select to VIDEO-2. You can not adjust CINEMA SURROUND function. You can adjust it in DVD Menu.

STEREO / I-II (I/II)

You can enjoy the stereo and bilingual broadcasted programmes.
Press the  I/II button to select the desired mode.

	Select stereo sound.
	Select monaural sound.
I	Select bilingual I (sub I).
II	Select bilingual II (sub II).

This function is not available in video mode.

To operate this function with a menu:

* (MENU) → (SOUND menu) → (STEREO / I-II)

EQUALIZER

You can adjust the sound level of each frequencies when selecting USER mode in SOUND MODE.

1 Select the USER in SOUND MODE under SOUND menu.

* (MENU) → (SOUND menu) → (SOUND MODE) → (USER)

2 Select the EQUALIZER in SOUND menu.

* (MENU) → (SOUND menu) → (EQUALIZER)

The following display appears.

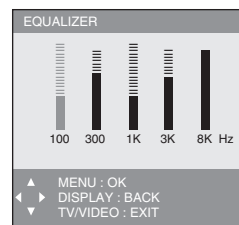

3 Select and adjust the desired frequencies.

4 Press the MENU/OK button to exit the menu.

Adjust high frequency will affect higher pitch sound and vice versa.

AI VOLUME

You can adjust the volume of all the channels and video inputs to the same level automatically depends on the strength of signal of the sources.

Select the AI VOLUME in SOUND menu, then choose ON or OFF.

* (MENU) → (SOUND menu) → (AI VOLUME)

* About the basic operations of the menu, please see the “How to operate menus and menus locations” on page 5.

DVD function

AUTO SIGNAL DETECT

When the DVD input signal is detected. The input mode will be changed to VIDEO-2 automatically.

For The DVD player, press the “POWER ON” button of the machine so that the signal can be detected.

For the VCR, press the “POWER ON” button of the machine, and then press the “PLAY” button, so that the signal can be detected and display DVD menu.

Select the AUTO SIGNAL DETECT in DVD MENU under FEATURES menu then choose ON or OFF (Factory setting is ON).

* (MENU) → (FEATURES menu) → (DVD MENU)
→ (AUTO SIGNAL DETECT)

DVD PICTURE MODE

You can enhance the picture quality of the DVD or VIDEO-2.

Select the DVD PICTURE MODE in DVD MENU under FEATURES menu, then choose the desired setting.

* (MENU) → (FEATURES menu) → (DVD MENU)
→ (DVD PICTURE MODE)

OFF Cancel the function.

CLEAR-1 Select when the disc is with lots of noise (To soften the picture).

CLEAR-2 Select when the disc is with less noise (To sharpen the picture).

TINT COLOUR

You can adjust the picture colour tone of the DVD.

Select the TINT COLOUR in DVD MENU under FEATURES menu, then adjust the level.

* (MENU) → (FEATURES menu) → (DVD MENU)
→ (TINT COLOUR)

WHITE BALANCE

You can change the white balance of the DVD picture.

Select the WHITE BALANCE in DVD MENU under FEATURES menu, then choose the desired setting.

* (MENU) → (FEATURES menu) → (DVD MENU)
→ (WHITE BALANCE)

For details, see “WHITE BALANCE” on page 10.

SOUND MODE

You can choose the desired sound setting for the DVD.

Select the SOUND MODE in DVD MENU under FEATURES menu, then choose the desired setting.

* (MENU) → (FEATURES menu) → (DVD MENU)
→ (SOUND MODE)

For details, see “SOUND MODE” on page 14.

CINEMA SURROUND

You can enjoy an enhanced sound for the DVD.

Select the CINEMA SURROUND in DVD MENU under FEATURES menu, then choose the desired setting.

* (MENU) → (FEATURES menu) → (DVD MENU)
→ (CINEMA SURROUND)

For details, see “CINEMA SURROUND” on page 15.

This function is not available when the SOUND MODE is set to SOUND TURBO.

** When you use VIDEO-2 to display the DVD signal or Video signal then WHITE BALANCE, VNR function in PICTURE menu/SHARP, TINT function in PICTURE SETTING menu/SOUND MODE, CINEMA SURROUND function in SOUND menu can't operate.

* About the basic operations of the menu, please see the “How to operate menus and menus locations” on page 5.

Customized setting

VNR

You can reduce the picture noise.

Select the VNR in the PICTURE menu, then choose a setting of VNR function.

* (MENU) → (PICTURE menu) → (VNR)

OFF	VNR is turned off.
AUTO	Effect of VNR is automatically controlled.
MIN	Effect of VNR becomes minimum level.
MAX	Effect of VNR becomes maximum level.

If you select MAX, the picture becomes softer even if the original picture is sharp.

When you select to VIDEO-2. You can not adjust VNR function.

LANGUAGE

You can choose your desired on screen display language.

Select the LANGUAGE in the INSTALL menu, then choose a language.

* (MENU) → (INSTALL menu) → (LANGUAGE)

CHILD LOCK

You can disable the front control buttons of the TV.

Select the CHILD LOCK in the FEATURES menu, then choose ON or OFF.

* (MENU) → (FEATURES menu) → (CHILD LOCK)

OFF TIMER

You can set the TV to turn off automatically to standby mode after a set time.

Press the OFF TIMER button to select a desired period of time.

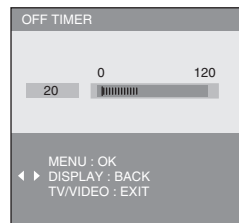

You can set the period of time to a maximum of 120 minutes in 10 minutes step.

To operate this function with a menu:

* (MENU) → (FEATURES menu) → (OFF TIMER)

When the elapsed of time left one minute, “GOOD NIGHT!” appears on the screen.

You can display the OFF TIMER menu again to confirm or change the remaining time.

* About the basic operations of the menu, please see the “How to operate menus and menus locations” on page 5.

Customized setting (continued)

VIDEO-2 SETTING

You can set the VIDEO-2 SETTING according to the video signal output from the external devices connected to the VIDEO-2 terminal.

Select the VIDEO-2 SETTING in INSTALL menu, then choose a setting (Factory setting is COMPONENT).

* (MENU) → (INSTALL menu) → (VIDEO-2 SETTING)

VIDEO	If a normal video signal (composite video signal) is input.
COMPONENT	If a component video signal (Y/C _B /C _R) is input.

You must choose a setting follow as signal that you input to VIDEO-2. (If you input the VIDEO Signal or VCR Signal to VIDEO-2, you must choose VIDEO-2 SETTING to VIDEO.)

For connecting methods, see “Additional Preparation” on page 22.

SETUP TOUR

You may use the SETUP TOUR function to perform the initial setting. When selecting SETUP TOUR, the LANGUAGE menu, TEXT LANGUAGE menu, AUTO PROGRAM menu, and EDIT menu will be displayed as shown on page 8. But “SETUP TOUR RESTART?” will not be displayed.

Select SETUP TOUR in the INSTALL menu.

* (MENU) → (INSTALL menu) → (SETUP TOUR)

DISPLAY

You can display the programme number, video terminal number and PR list on the screen.

Press the DISPLAY button to select the desired mode:

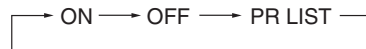

Choose a TV channel or a VIDEO terminal.

- 1 Press the DISPLAY button to display the PR LIST.
- 2 Select a programme number or video terminal by pressing the ▲/▼ button to move up/down on the programme number or press the ◀/▶ button to skip for each 7 programme numbers, then press MENU/OK button.

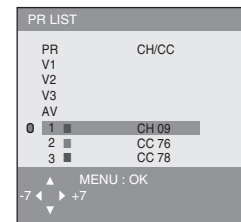

- * About the basic operations of the menu, please see the “How to operate menus and menus locations” on page 5.

TV channel presetting

To register the TV channels automatically (AUTO PROGRAM)

You can register the TV channels into the TV's channel list automatically.

- 1 Display the INSTALL menu.

* (MENU) ➔ (INSTALL menu)

- 2 Choose AUTO PROGRAM, then press the MENU/OK button. AUTO PROGRAM function starts, and the channels received are registered in the channel list (PR LIST) automatically.

- 3 The EDIT menu appears.

To edit the channel list	Proceed to the Step 3 of "To edit the channel list (PR LIST)" on page 20.
If a channel is not registered	Proceed to the Step 3 of "To register the TV channels manually" on this page.
To exit the menu	Press the MENU/OK button.

To register the TV channels manually (MANUAL in the EDIT menu)

You can register the TV channels into the TV's channel list manually.

- 1 Display the INSTALL menu.

* (MENU) ➔ (INSTALL menu)

- 2 Choose EDIT/MANUAL, then press the MENU/OK button. EDIT menu appears.

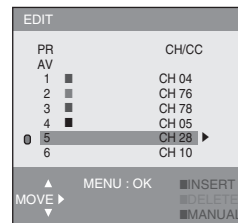

- 3 Choose the channel which you want to register.
- 4 Press the blue button to activate the MANUAL function. The sound system of the channel appears at the right of the CH//CC number.
- 5 Press the ▶ button to choose an appropriate sound system. For details, see "SOUND SYSTEM" on page 14.
- 6 Press the green or red button to search for the TV channel. Searching stops when a channel is found and displayed.
- 7 Repeat step 5 until your desired TV channel appears.

If the reception is poor Press the blue or yellow button to fine tune the TV channel.

If noisy sound is heard Press the ▶ button to choose an appropriate sound system.

- 8 Press the MENU/OK button to exit the menu.

* About the basic operations of the menu, please see the "How to operate menus and menus locations" on page 5.

TV channel presetting (continued)

To edit the channel list (PR LIST) (MOVE and DELETE in the EDIT menu)

You can edit the TV channel list as you like.

Note: After this operation, other channel's PR numbers will be changed.

- 1 Display the INSTALL menu.

* (MENU) ➔ (INSTALL menu)

- 2 Choose EDIT/MANUAL, then press the MENU/OK button.
EDIT menu appears.

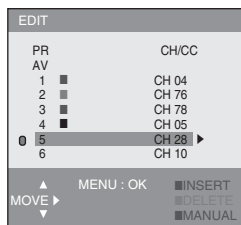

- 3 Choose the channel which you want to change PR number, or delete.

- 4 Do the following action:

To change the PR number (MOVE)	Press the ▶ button. Then move it to the PR number you want to use it for the channel. Finally press the ◀ button.
--------------------------------	---

To delete the channel (DELETE)	Press the yellow button.
--------------------------------	--------------------------

- 5 Press the MENU/OK button to exit the menu.

To add in the new channel (INSERT in the EDIT menu)

You can add in the new channel in the TV channel list as you like. You need to find the "CH/CC" number for the TV channel. Find the "CH/CC" number corresponding to the channel number of the TV channel from the attached sheet "CH/CC number list" on page 21.

- 1 Display the INSTALL menu.

* (MENU) ➔ (INSTALL menu)

- 2 Choose EDIT/MANUAL, then press the MENU/OK button.
EDIT menu appears.

- 3 Choose the PR number for which you will register a new TV channel. When you add a new TV channel of NTSC-M system, press the SOUND SYSTEM button to change the sound system to M. Then proceed to the next step.

- 4 Press the green button, then press ▶ buttons to choose "CC" or "CH".

- 5 Press the number button to enter the remaining CH/CC number.

The TV starts to search the TV channel, and the picture of the TV channel appears. If the TV finds no TV channel, a noisy picture appears.

When a TV channel has already been registered in PR99, using the INSERT function deletes that TV channel.

* About the basic operations of the menu, please see the "How to operate menus and menus locations" on page 5.

TV channel presetting (continued)

CH/CC number

When you want to use the INSERT function on page 20, find the CH/CC number corresponding to the channel number of the TV channel from this table.

Channel No. Country

US	United States, Philippines, etc..
CCIR	Middle East, Southeast Asia, etc..
OIRT	Eastern Europe, Russia, Vietnam, etc..
AUSTRALIA	Australia, etc..

Channel

CH	US	CCIR	OIRT	AUSTRALIA
CH 02	US-2	E2	R1	AU-0
CH 03	US-3	E3		AU-1
CH 04	US-4	E4	R2	AU-2
CH 05	US-5	E5	R6	AU-6
CH 06	US-6	E6	R7	AU-7
CH 07	US-7	E7	R8	AU-8
CH 08	US-8	E8	R9	AU-9
CH 09	US-9	E9		
CH 10	US-10	E10	R10	AU-10
CH 11	US-11	E11	R11	AU-11
CH 12	US-12	E12	R12	
CH 13	US-13			
CH 14	US-14, W+29			
CH 15	US-15, W+30			
CH 16	US-16, W+31			
CH 17	US-17, W+32			
CH 18	US-18, W+33			
CH 19	US-19, W+34			
CH 20	US-20, W+35			
CH 21	US-21, W+36	E21		
CH 22	US-22, W+37	E22		
CH 23	US-23, W+38	E23		
CH 24	US-24, W+39	E24		
CH 25	US-25, W+40	E25		
CH 26	US-26, W+41	E26		
CH 27	US-27, W+42	E27		
CH 28	US-28, W+43	E28		AU-28
CH 29	US-29, W+44	E29		AU-29
CH 30	US-30, W+45	E30		AU-30
CH 31	US-31, W+46	E31		AU-31/AU-32
CH 32	US-32, W+47	E32		AU-33

CH	US	CCIR	OIRT	AUSTRALIA
CH 33	US-33, W+48	E33		AU-34
CH 34	US-34, W+49	E34		AU-35
CH 35	US-35, W+50	E35		AU-36
CH 36	US-36, W+51	E36		AU-37
CH 37	US-37, W+52	E37		AU-38
CH 38	US-38, W+53	E38		AU-39/AU-40
CH 39	US-39, W+54	E39		AU-41
CH 40	US-40, W+55	E40		AU-42
CH 41	US-41, W+56	E41		AU-43
CH 42	US-42, W+57	E42		AU-44
CH 43	US-43, W+58	E43		AU-45
CH 44	US-44, W+59	E44		AU-46
CH 45	US-45, W+60	E45		AU-47/AU-48
CH 46	US-46, W+61	E46		AU-49
CH 47	US-47, W+62	E47		AU-50
CH 48	US-48, W+63	E48		AU-51
CH 49	US-49, W+64	E49		AU-52
CH 50	US-50, W+65	E50		AU-53
CH 51	US-51, W+66	E51		AU-54
CH 52	US-52, W+67	E52		AU-55/AU-56
CH 53	US-53, W+68	E53		AU-57
CH 54	US-54, W+69	E54		AU-58
CH 55	US-55, W+70	E55		AU-59
CH 56	US-56, W+71	E56		AU-60
CH 57	US-57, W+72	E57		AU-61
CH 58	US-58, W+73	E58		AU-62
CH 59	US-59, W+74	E59		AU-63/AU-64
CH 60	US-60, W+75	E60		AU-65
CH 61	US-61, W+76	E61		AU-66
CH 62	US-62, W+77	E62		AU-67
CH 63	US-63, W+78	E63		AU-68
CH 64	US-64, W+79	E64		AU-69
CH 65	US-65, W+80	E65		
CH 66	US-66, W+81	E66		
CH 67	US-67, W+82	E67		
CH 68	US-68, W+83	E68		
CH 69	US-69, W+84	E69		

CC	US	CCIR	OIRT	AUSTRALIA
CC 01		S-1		AU-5
CC 02		S-2		
CC 03		S-3		
CC 04		S-4		
CC 05		S-5		
CC 06		S-6		AU-5A
CC 07		S-7		
CC 08		S-8		
CC 09		S-9		
CC 10		S-10		
CC 11		S-11		
CC 12		S-12		
CC 13		S-13		
CC 14	A	S-14		
CC 15	B	S-15		
CC 16	C	S-16		
CC 17	D	S-17		

CC	US	CCIR	OIRT	AUSTRALIA
CC 18	E	S-18		
CC 19	F	S-19		
CC 20	G	S-20		
CC 21	H	S-21		
CC 22	I	S-22		
CC 23	J	S-23		
CC 24	K	S-24		
CC 25	L	S-25		
CC 26	M	S-26		
CC 27	N	S-27		
CC 28	O	S-28		
CC 29	P	S-29		
CC 30	Q	S-30		
CC 31	R	S-31		
CC 32	S	S-32		
CC 33	T	S-33		
CC 34	U	S-34		
CC 35	V	S-35		
CC 36	W	S-36		
CC 37	W+1	S-37		
CC 38	W+2	S-38		
CC 39	W+3	S-39		
CC 40	W+4	S-40		
CC 41	W+5	S-41		
CC 42	W+6			
CC 43	W+7			
CC 44	W+8			
CC 45	W+9			
CC 46	W+10			
CC 47	W+11			
CC 48	W+12			
CC 49	W+13			
CC 50	W+14			
CC 51	W+15			
CC 52	W+16			
CC 53	W+17			
CC 54	W+18			
CC 55	W+19			
CC 56	W+20			
CC 57	W+21			
CC 58	W+22			
CC 59	W+23			
CC 60	W+24			
CC 61	W+25			
CC 62	W+26			
CC 63	W+27			
CC 64	W+28			
CC 75		X		
CC 76		Y	R3	
CC 77		Z	R4	AU-3
CC 78		Z+1	R5	
CC 79		Z+2		AU-4
CC 85	A-5			
CC 96	A-4			
CC 97	A-3			
CC 98	A-2			
CC 99	A-1			

Additional preparation

The illustrations shown in this section are for AV-29VX15 and AV-21MX75 only, which are used for explanation purpose. Your TV may not look exactly the same as illustrated.

Before connecting

- Read the manuals provided with the devices for the proper connection.
- Turn off all the devices including the TV.
- Note that connecting cables are not supplied.

Connecting to front video input terminal

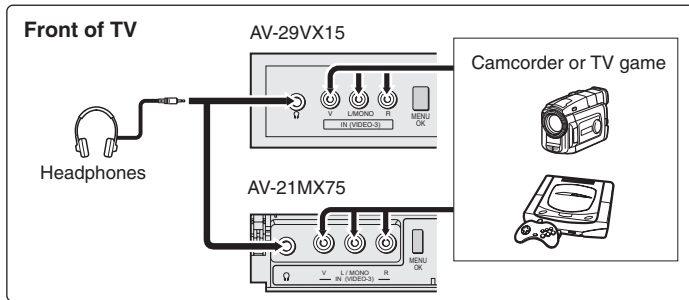

Connecting to rear component/video input terminal and output terminal

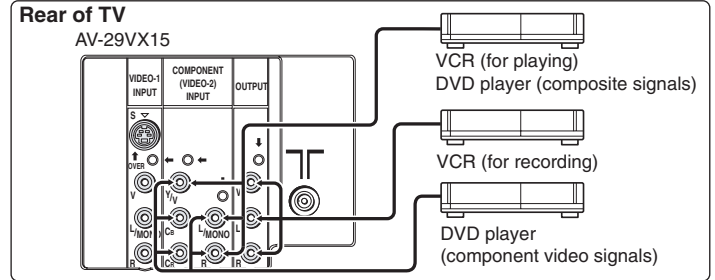

When you use VIDEO-1 INPUT, you should choose to connect S-VIDEO or video input. If S-VIDEO connector and video input are connected at the same time, no picture displays on the screen and the message "PLEASE DISCONNECT VIDEO-1 CABLE!" appears. In this case, you should disconnect either S-VIDEO or video input.

When connecting to COMPONENT (VIDEO-2) input, depending on the connection, choose the appropriate video input using the menu (see page 18).

Troubleshooting

If a problem occurs when you are using the TV, check the below troubleshooting guide before calling for repair.

• No picture, no sound	• Deactivate the BLUE BACK function if it is turned on. • Choose the appropriate sound system. Refer to "SOUND SYSTEM" on page 14.
• Snowy picture	• Check the aerial cable and its connection with the TV.
• Stripes appear on the picture	• Interference occurs caused by other devices such as an amplifier, personal computer, or a hair drier. Move such devices away from your TV.
• Double-pictures (ghosting) occur	• Interference occurs caused by signal reflecting from mountains or building. Try to adjust the aerial's direction or use a better directionality antenna.
• Poor picture	• Choose the appropriate colour system. Refer to "COLOUR SYSTEM" on page 9. • Adjust the COLOUR or BRIGHT setting. Refer to "PICTURE SETTING" on page 10.
• White and bright still image look as if it were coloured	• Inevitable phenomenon due to the nature of the picture tube. This is not a malfunction.
• Top of the image from software products or video tape is distorted	• This is due to the condition of the video signal whereby the image was not recorded properly. This is not a malfunction.
• Poor sound	• Adjust the sound frequency properly. Refer to "EQUALIZER" on page 15.
• Stereo or bilingual sound is unclear	• TV channel reception is poor. Change the stereo/bilingual mode to mono sound (see page 15).
• Cannot operate the remote control	• The batteries may be exhausted. Replace with new batteries (see page 7). • Ensure that you are operating the remote less than seven meters from the front of your TV.
• Cannot operate the menus	• Press TV/VIDEO button to return to TV mode and try operating the menus.
• Cannot operate the front control buttons	• Deactivate the CHILD LOCK function if it is turned on (see page 17).

• Colour patches appear at the corner of the screen	• This may due to the magnetized device such as a speaker near to your TV. Keep the device apart from your TV. Alternately, you can also use the magnetic-shielded speaker.
• Picture is tilted	• This may due to the earth magnetism. Refer to "PICTURE TILT" on page 11 to correct the tilt.
• Image takes a short period to be displayed	• Image required time to stabilize before display. This is not a malfunction.
• TV may emitted crackling sound	• This is due to a sudden change in temperature and it is not a malfunction. If the crackling sound is too frequent, request your service technician for inspection.
• Feel a slight electric shock when touching the TV screen	• This is due to the static electricity of the picture tube and it will not harm the human body. This is not a malfunction.
• After you connect the signal to VIDEO-2 and playback VCR or DVD Player, the Auto Detect does not work.	• Please check that the AUTO SIGNAL DETECT function is on or off. • Press button (VCR or DVD Player) to turn the machine off and turn it on again; do not turn the machine off and on suddenly. • Inspect the video cable connection on VIDEO-2 that they are connected properly.
• When you are watching another channel that is not VIDEO-2, AUTO SIGNAL DETECT works while VCR or DVD Player was on.	• Inspect the video cable connection on VIDEO-2 that they are connected properly. • In a certain VCR or DVD Player, the function might operate by the discontinuity of the signal.
• While you are watching TV on the other channels, AUTO SIGNAL DETECT work when you press ◀▶ or on the front panel of VCR or DVD Player.	• In a certain VCR or DVD Player, the function might operate by the discontinuity of the signal.
• After TV was on, AUTO SIGNAL DETECT work.	• Video signal from VCR or DVD Player cause the function run properly to indicate that there are video signal on VIDEO-2 channel.

Specifications

TV RF systems

B, G, I, D, K, M

Colour systems

PAL, SECAM, NTSC 3.58 MHz, NTSC 4.43 MHz

Receiving channels

VHF low channel (VL), VHF high channel (VH), UHF channel (U)
Receives cable channels in mid band, super band and hyper band.

Power requirements

AC 110 to 240 V, 50 Hz / 60 Hz

External input / output

VIDEO-1:	S-video input, VIDEO input, AUDIO L/R input
VIDEO-2/COMPONENT:	VIDEO input, AUDIO L/R input, COMPONENT VIDEO (Y/C _B /C _R) input
VIDEO-3:	VIDEO input, AUDIO L/R input
OUTPUT:	VIDEO output, AUDIO L/R output
Headphone jack:	Stereo mini jack (3.5 mm diameter)

**Sound-multiplex systems

A2(B/G) or NICAM (B/G, I, D/K)

**Teletext system

FLOF (Fastext), WST (World Standard Text)

**Language displayed by teletext

Please see the table in the description "TEXT LANGUAGE" on page 13.

**Depends on the models, STEREO/II function for the Sound-multiplex systems or Teletext function may not be available. Please confirm with the chart on page 3.

Design and specifications subject to change without notice.

JVC